



STEEL STAR
www.greatforming.com



Mais de 15 anos de experiência em máquinas de conformação de rolos



Planos claros Preços claros. Faça o melhor plano para você

Máquina de conformação de rolos

Conteúdo



Perfil de companhia



Exposições



Parceiros estrangeiros



STEEL STAR
www.greatforming.com

Conteúdo



Catálogo de produtos

1. Máquina de conformação de rolos de chapas de telhado
2. Máquina formadora de rolos de quilha de aço para teto/parede divisória
3. Máquina de conformação de rolos para portas de venezianas
4. Máquina de conformação de rolos de purlin C/Z
5. Máquina de conformação de rolos para cumeeira
6. Máquina formadora de rolo corrugado de barril horizontal
7. Máquina formadora de rolo para deck de piso
8. Máquina formadora de rolo para painel lateral de automóvel
9. Máquina de conformação de rolos para calhas pluviais/canos de descida



STEEL STAR
www.greatforming.com

Conteúdo



Catálogo de produtos

10. Máquina perfiladeira de estrutura de villa de aço leve
11. Máquina de conformação de rolos de chapa de guarda-corpo
12. Linha de produção de compósitos para telhados de espuma/lã de rocha
13. Máquina de chapas para painéis de telhado Decoiler/Auto Stacker
14. Máquina de dobra hidráulica/máquina de corte hidráulica
15. Máquina de linha de corte de bobina de aço
16. Máquina de conformação de rolos de suporte solar
17. Máquina de fazer tubos de aço
18. Vários produtos podem ser personalizados

Conteúdo



Envio



Serviço



Contate-nos



STEEL STAR
www.greatforming.com

Perfil de companhia

**A fábrica cobre uma área
de 20000m²**

Fábrica de produção real

Serviço online 24 horas

**15 anos de experiência na
indústria**

**Cooperou com mais de
30 países**



Planos claros Preços claros

**Software de design
alemão Copra**



**Tem muitos parceiros
estrangeiros**

**Obteve várias
certificações
internacionais**



STEEL STAR
www.greatforming.com

Visão da fábrica da empresa

Área da Fábrica



Oficina de Usinagem de Matérias-Primas



Workshop de Produção de Montagem





STEEL STAR
www.greatforming.com

Certificado de Honra da Empresa





STEEL STAR
www.greatforming.com

Exposições

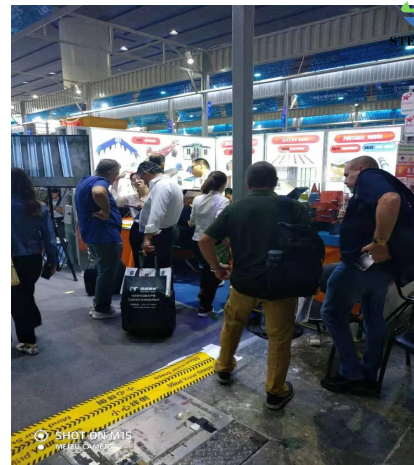
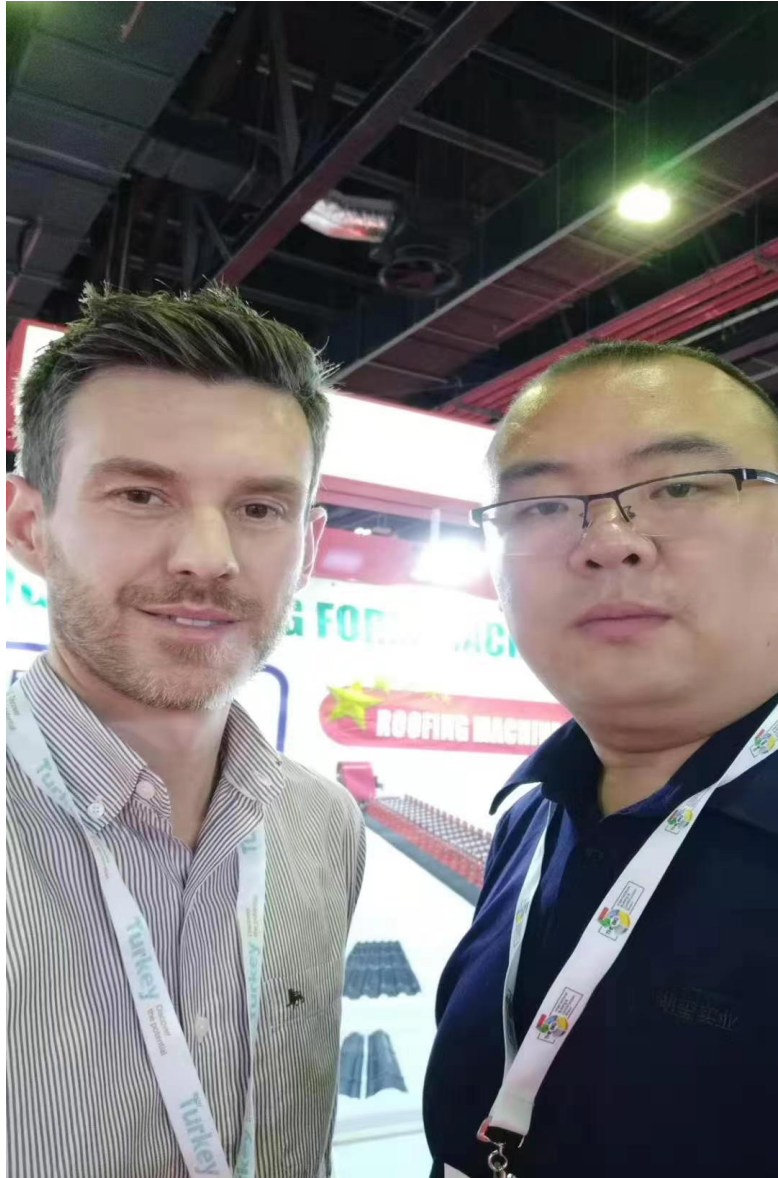



STEEL STAR
www.greatforming.com

Parceiros estrangeiros





STEEL STAR
www.greatforming.com

Catálogo de produtos

1. Máquina de conformação de rolos de chapas de telhado

1-1 Máquina de formação de rolos de chapas trapezoidais de modelo único

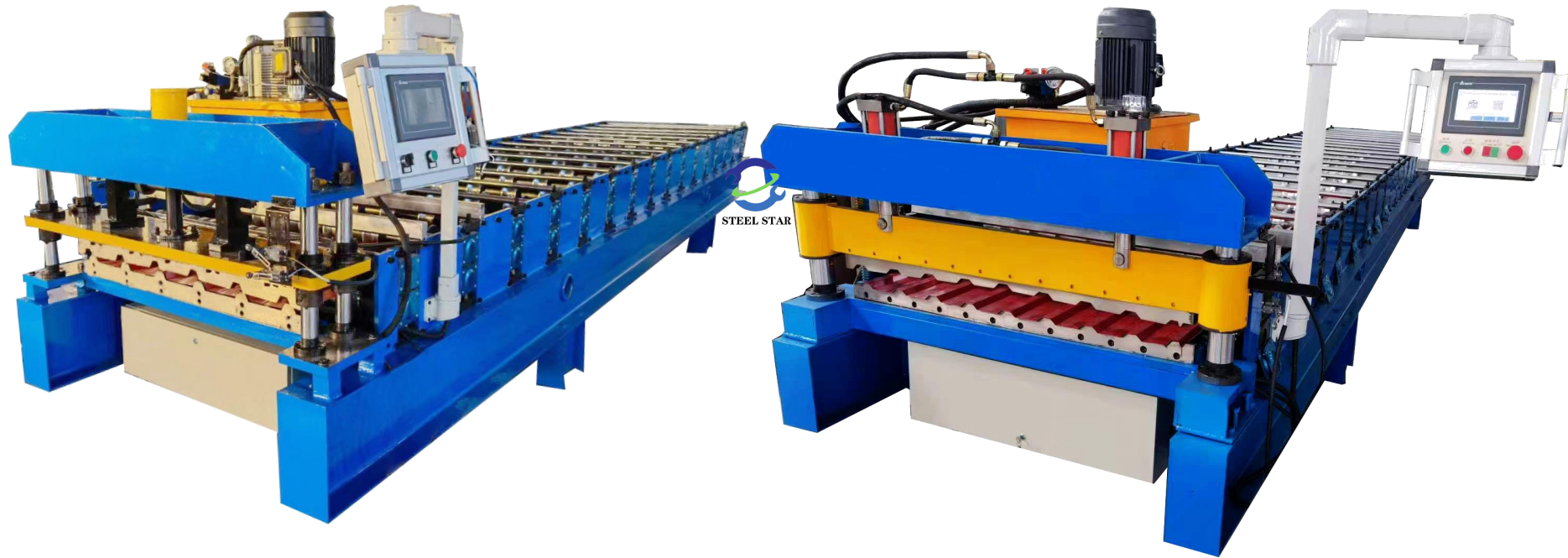

Cenários de aplicação





STEEL STAR
www.greatforming.com

Catálogo de produtos

1. Máquina de conformação de rolos de chapas de telhado

1-1 Máquina de formação de rolos de chapas trapezoidais de modelo único

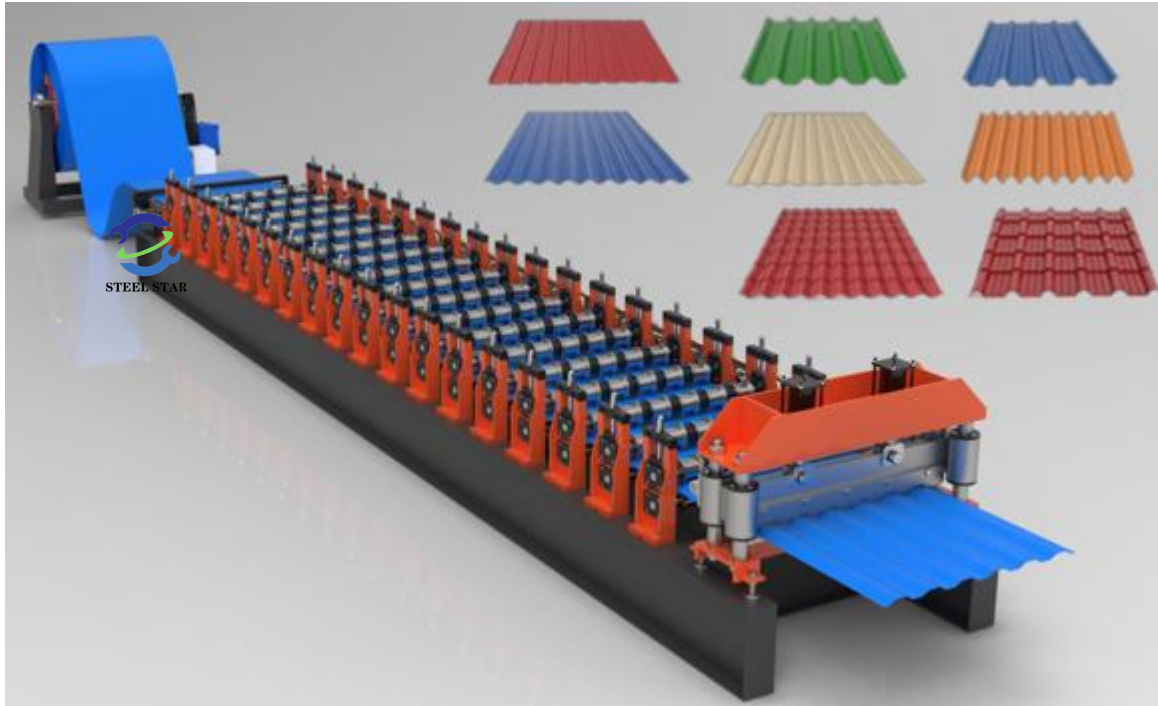

Trapezoidal roofing sheet

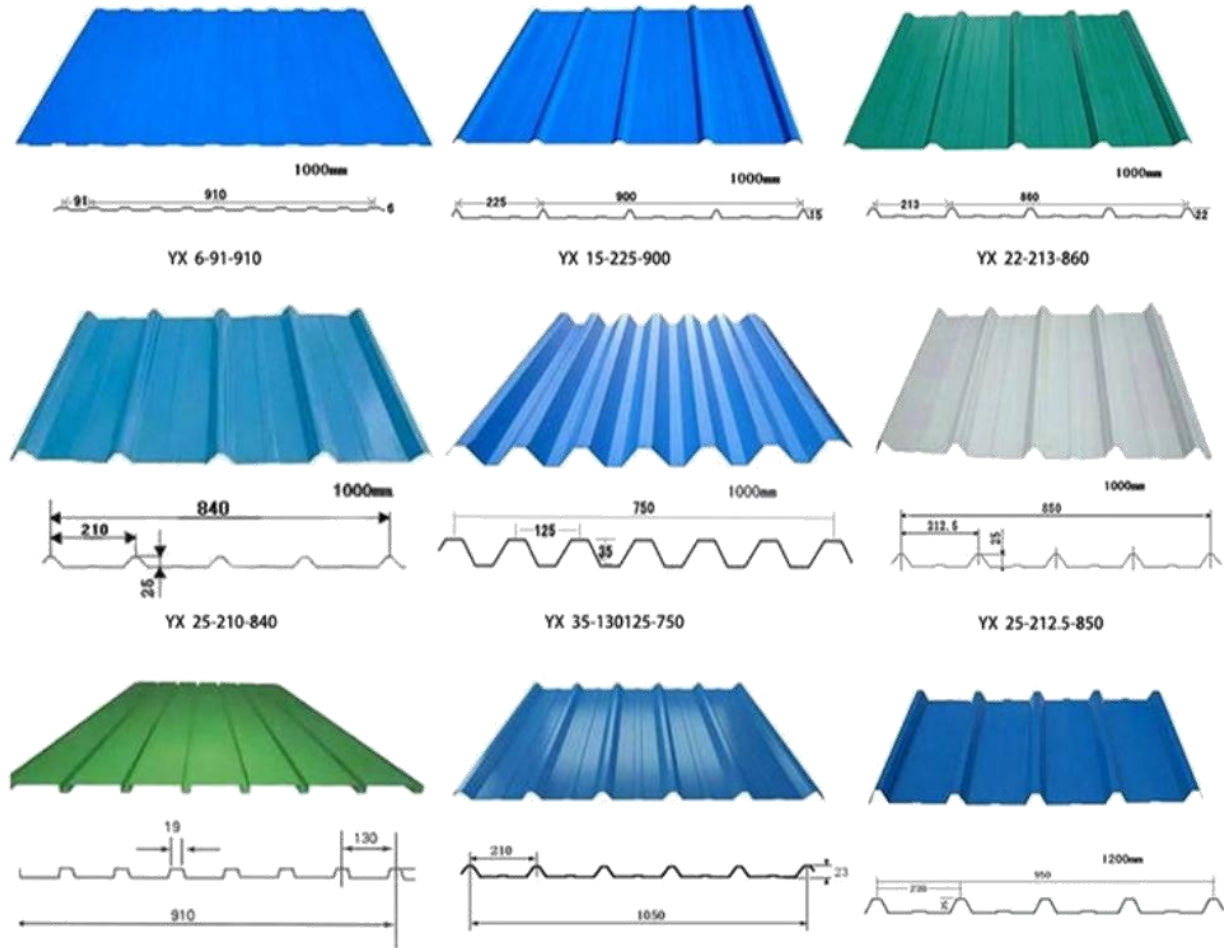



STEEL STAR
www.greatforming.com

Catálogo de produtos

1. Máquina de conformação de rolos de chapas de telhado

1-2 Máquina de formação de rolos de chapa ondulada de modelo único

Cenários de aplicação





STEEL STAR
www.greatforming.com

Catálogo de produtos

1. Máquina de conformação de rolos de chapas de telhado

1-2 Máquina de formação de rolos de chapa ondulada de modelo único

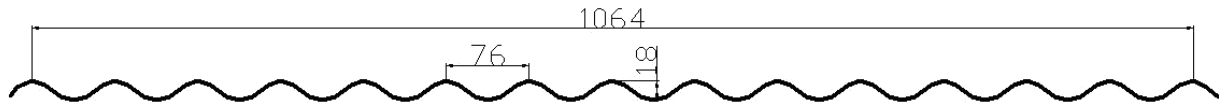

进料宽度: 1250mm

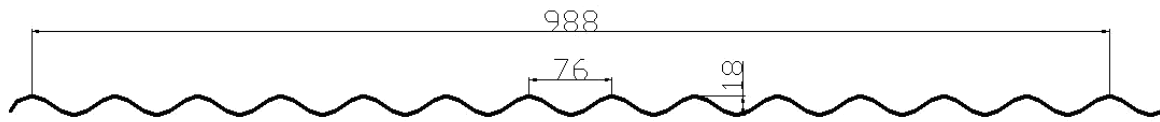

进料宽度: 1200mm

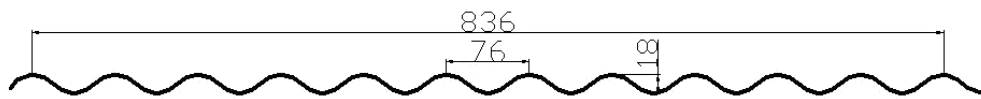

进料宽度: 1000mm

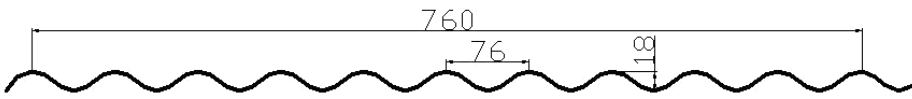

进料宽度: 940mm

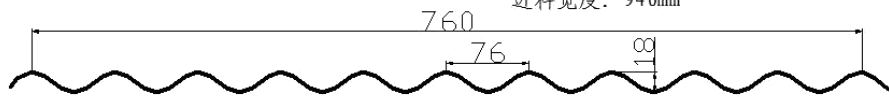

进料宽度: 914mm

Wave roofing sheet

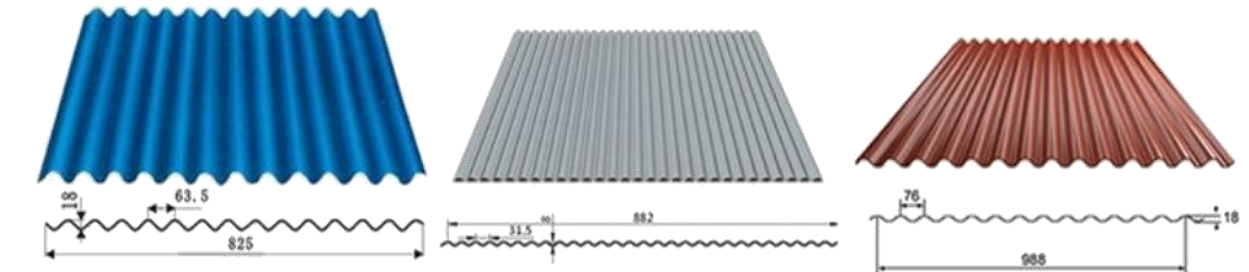

YX 18-63.5-825

YX 8-31.5-882

YX 18-76-988

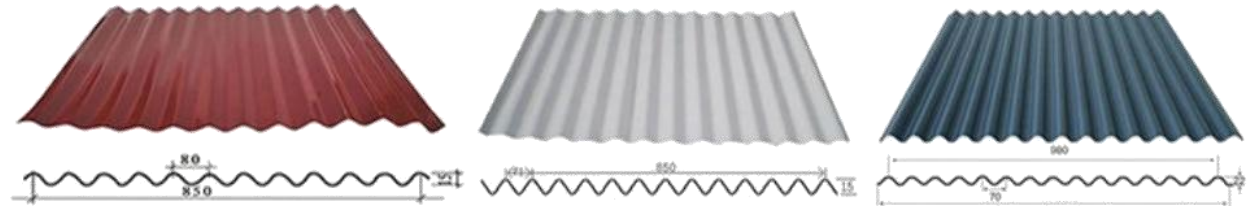

YX 15-80-850

YX 15-71-850

YX 22-70-980

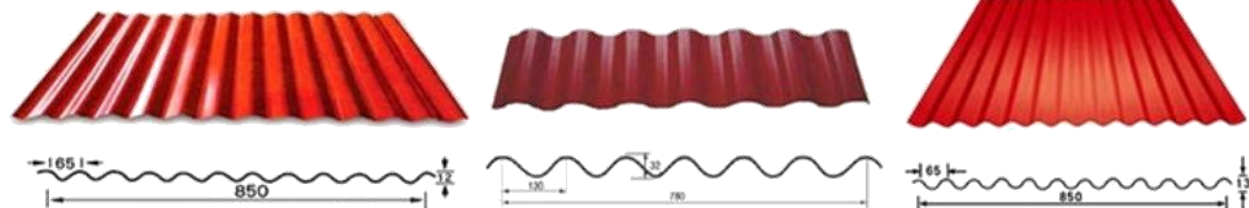

YX 12-65-850

YS 32-130-780

YS 13-65-850



STEEL STAR
www.greatforming.com

Catálogo de produtos

1. Máquina de conformação de rolos de chapas de telhado

1-3 Máquina de formação de rolos para telhados de telhas esmaltadas de modelo único

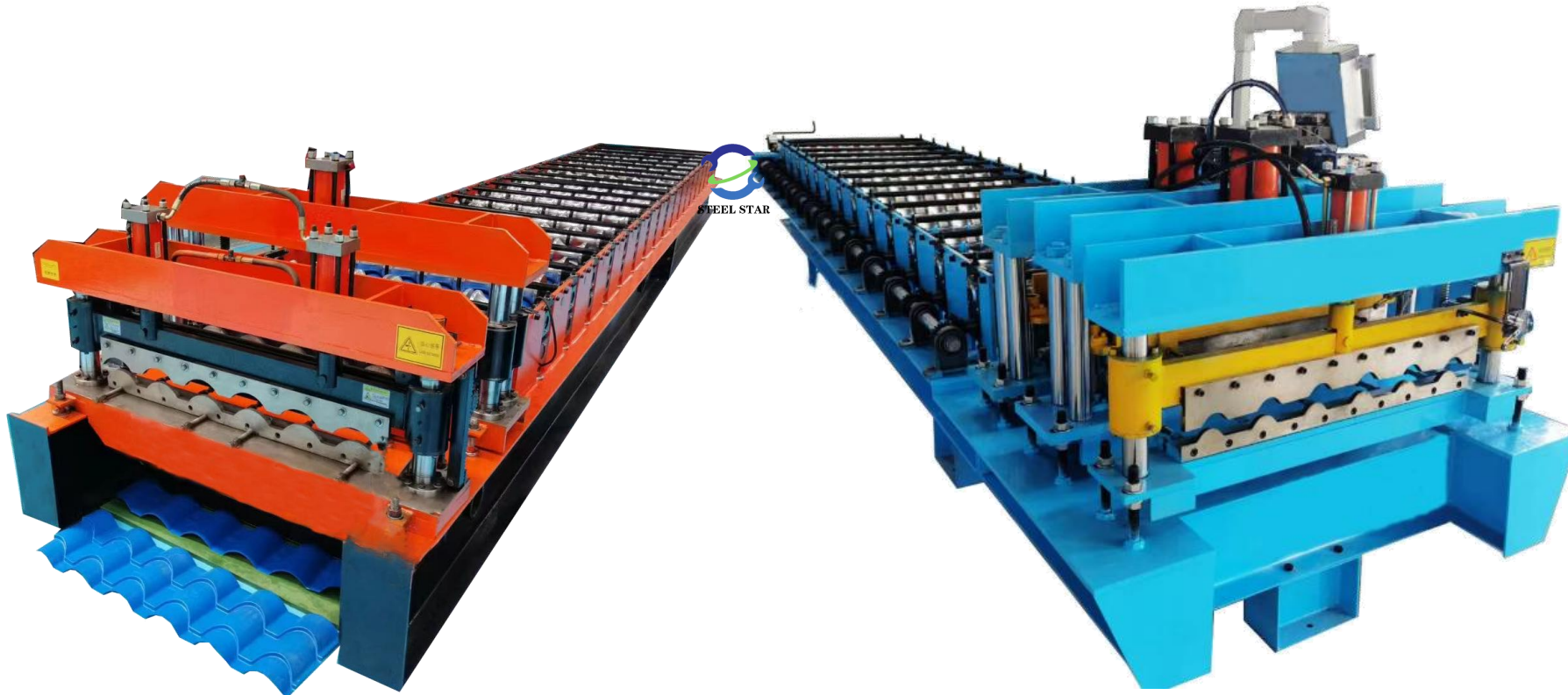

Cenários de aplicação





STEEL STAR
www.greatforming.com

Catálogo de produtos

1. Máquina de conformação de rolos de chapas de telhado

1-3 Máquina de formação de rolos para telhados de telhas esmaltadas de modelo único



Glazed roofing sheet

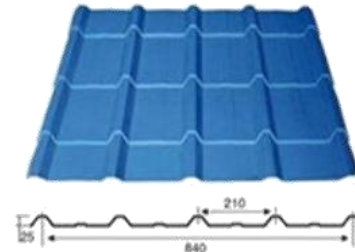

YX 25-210-840

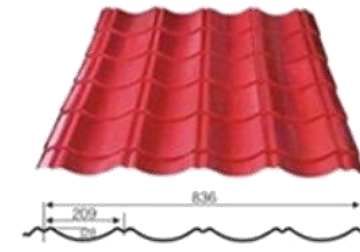

YX 28-29-836

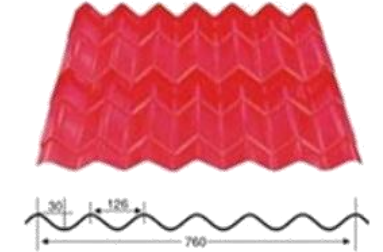

YX 30-126-760

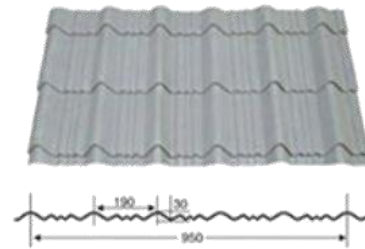

YX 30-190-950

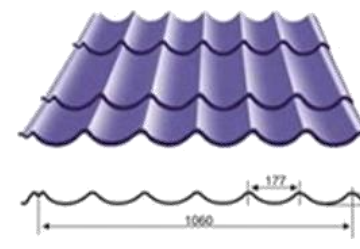

YX 30-177-1060

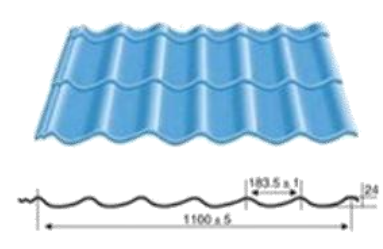

YX 24-183.5-1100

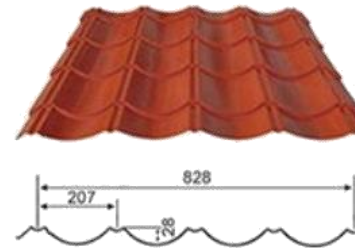

YX 28-207-828

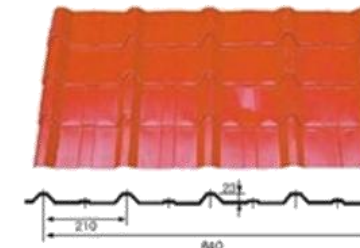

YX 28-207-828

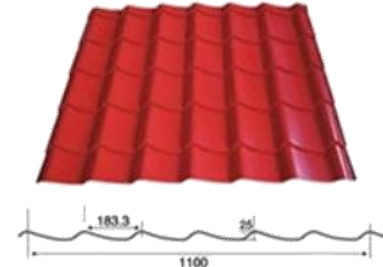

YX 25-183.3-1100



STEEL STAR
www.greatforming.com

Catálogo de produtos

1. Máquina de conformação de rolos de chapas de telhado

1-4 Máquina de formação de rolos para chapas de telhado de camada dupla/modelos duplos



Cenários de aplicação





STEEL STAR
www.greatforming.com

Catálogo de produtos

1. Máquina de conformação de rolos de chapas de telhado

1-5 Máquina de formação de rolos para telhas esmaltadas de camada dupla/modelos duplos

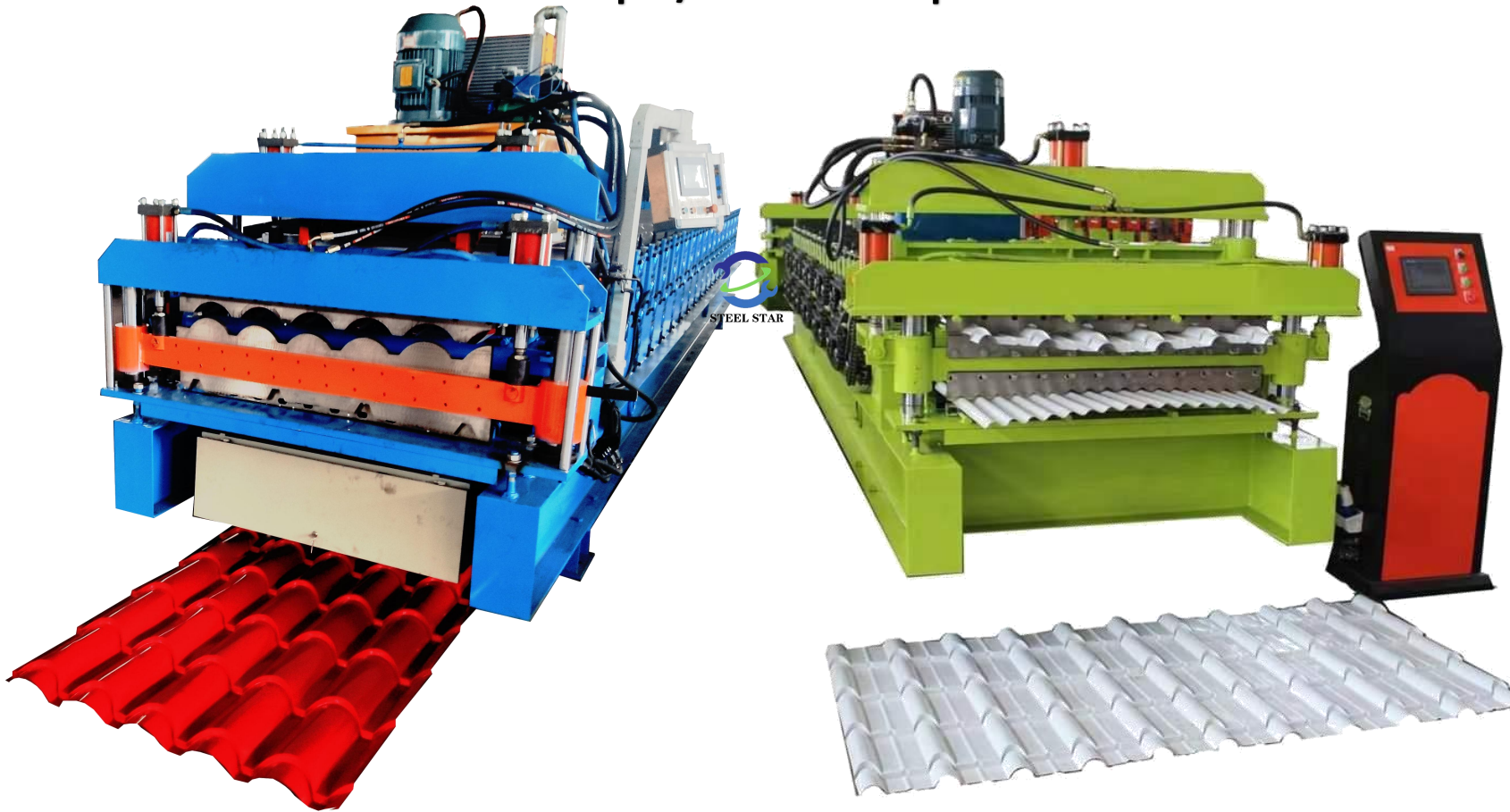

Cenários de aplicação





STEEL STAR
www.greatforming.com

Catálogo de produtos

1. Máquina de conformação de rolos de chapas de telhado

1-6 Máquina de formação de rolos para chapas de telhado de três camadas/três modelos

Cenários de aplicação





STEEL STAR
www.greatforming.com

Catálogo de produtos

1. Máquina de conformação de rolos de chapas de telhado

1-7 Máquina de arqueamento de chapas de telhado totalmente automática

Cenários de aplicação

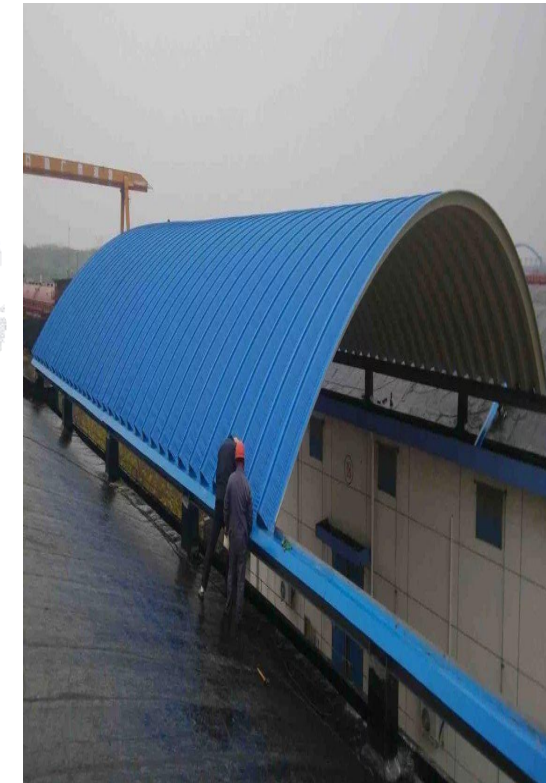
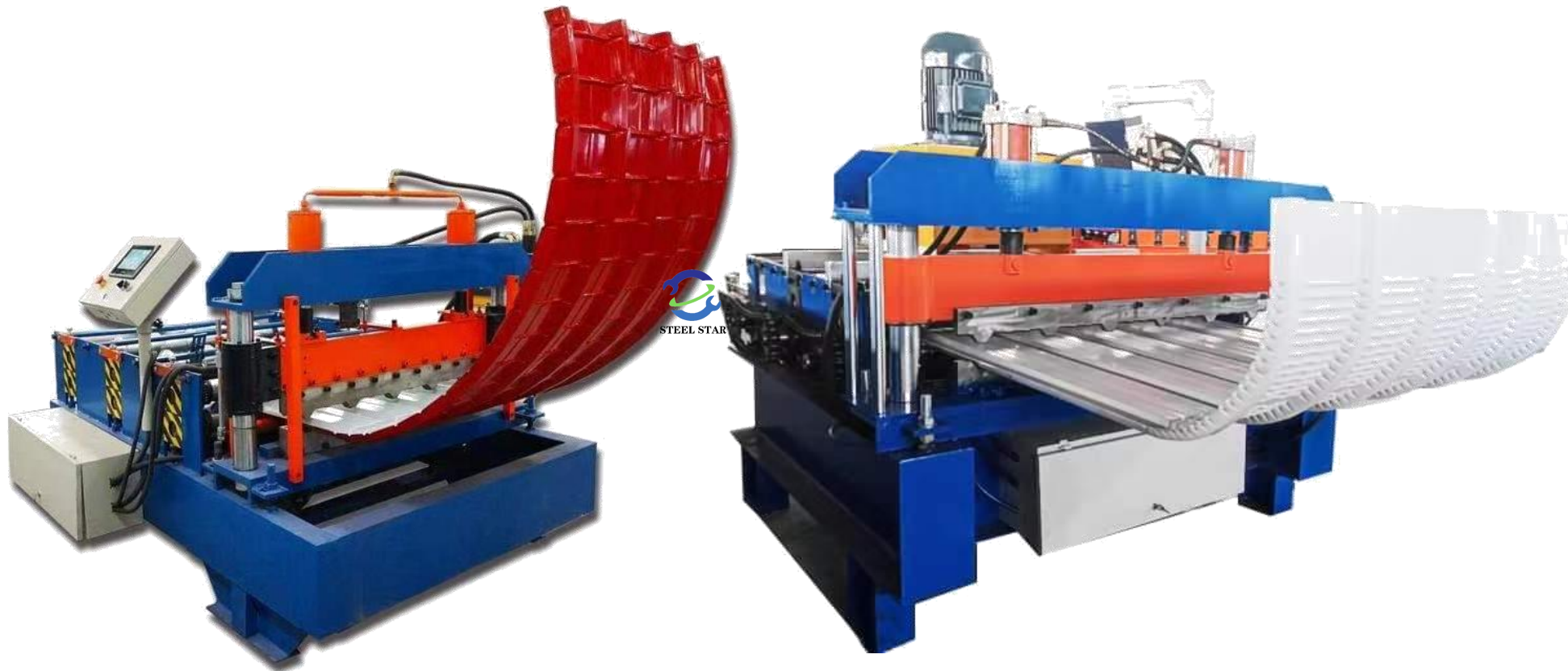



STEEL STAR
www.greatforming.com

Catálogo de produtos

2. Máquina formadora de rolos de quilha de aço para teto/parede divisória

2-1 Máquina de conformação de rolos C/U/V/Omega para quilha leve e trilhos

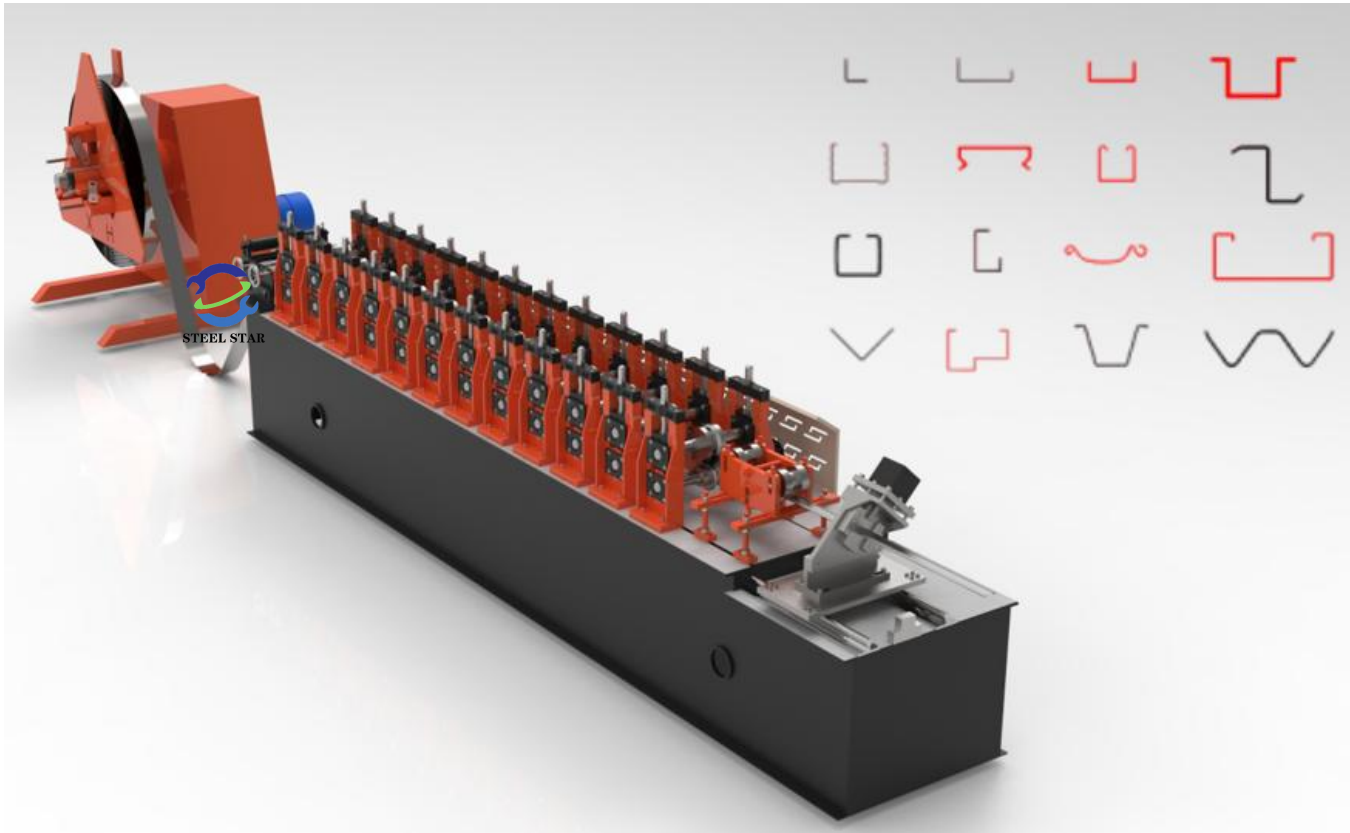

Alta velocidade

20 metros -- 150metros/minuto

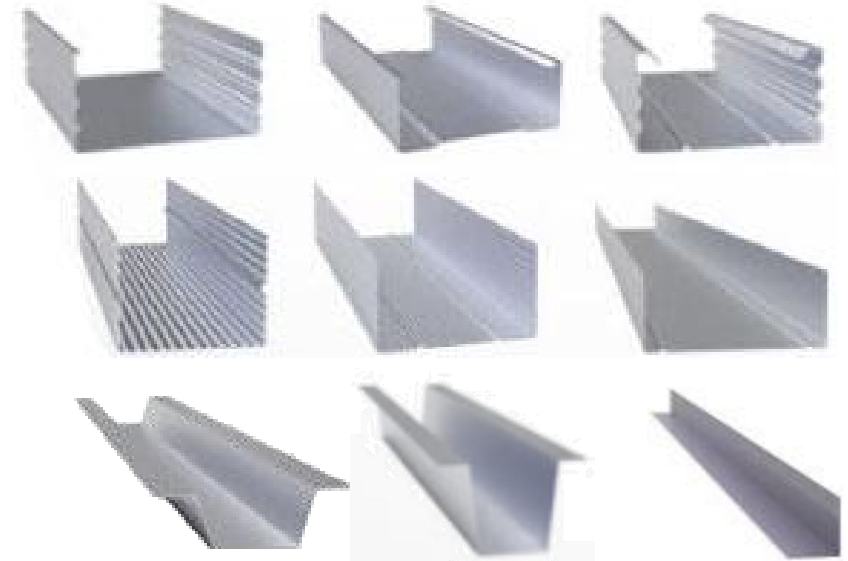



STEEL STAR
www.greatforming.com

Catálogo de produtos

2. Máquina formadora de rolos de quilha de aço para teto/parede divisória

2-1 Máquina de conformação de rolos C/U/V/Omega para quilha leve e trilhos

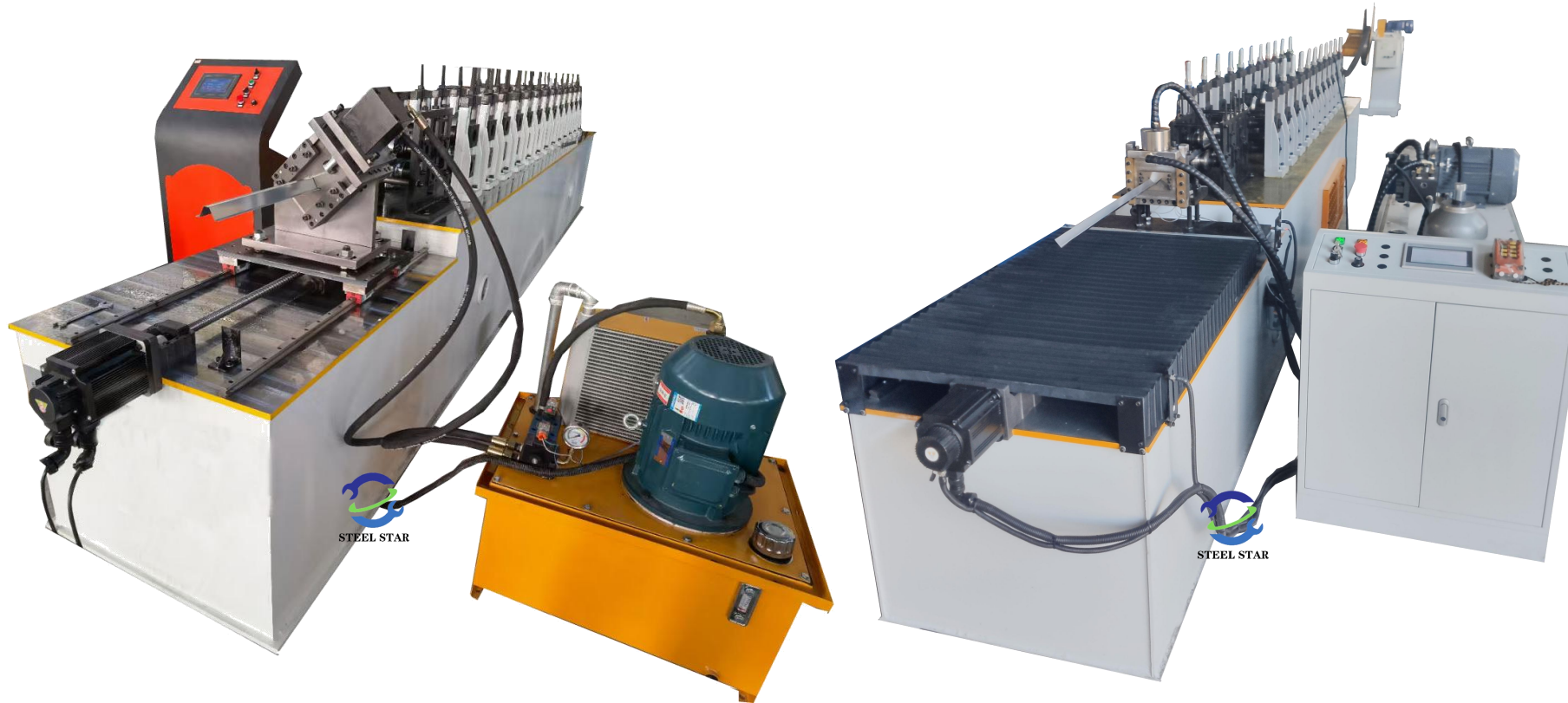

Cenários de aplicação

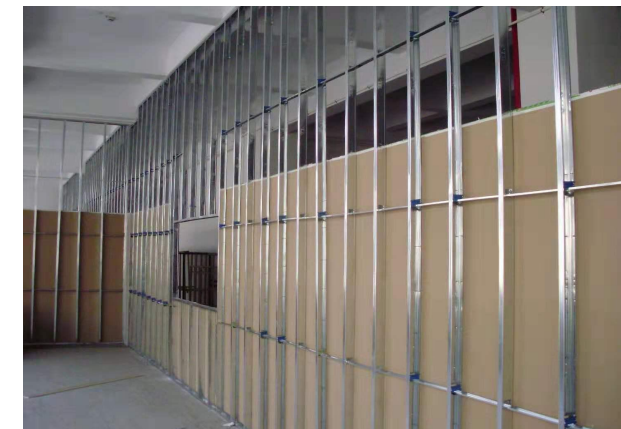



Máquina de conformação de rolos de quilha leve de alta velocidade

STEEL STAR
www.greatforming.com

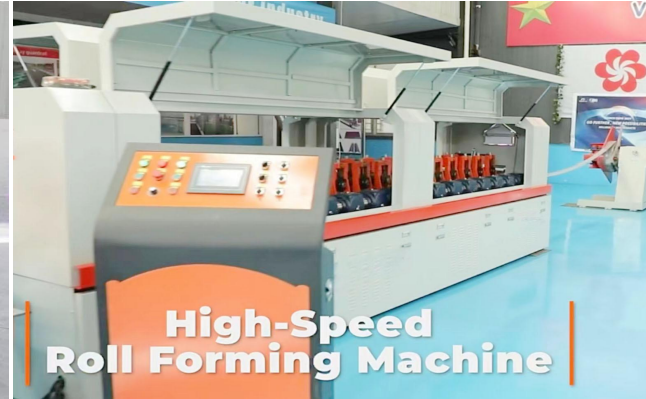

High-Speed Roll Forming Machine

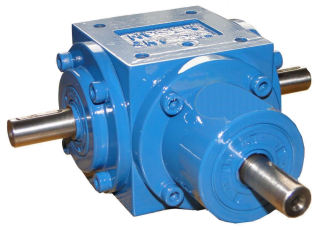

Estrutura da caixa de engrenagens
Alta velocidade 50 metros-150 metros/minuto

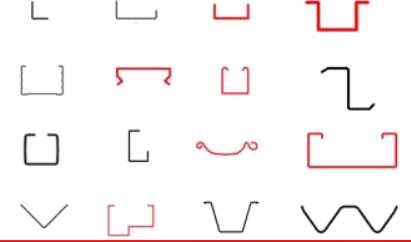

C--Modelo

U--Modelo

V--Modelo

Omega--Modelo

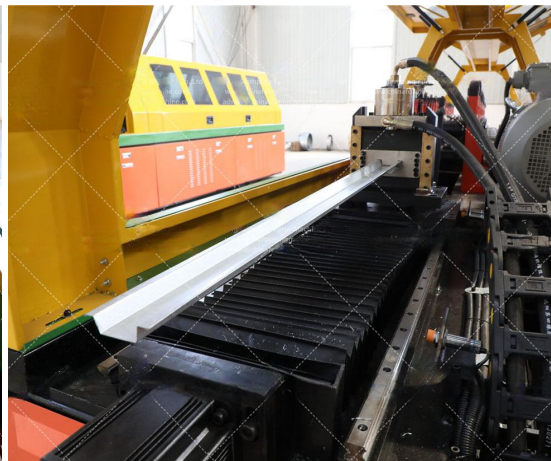



STEEL STAR
www.greatforming.com

Catálogo de produtos

3. Máquina de conformação de rolos para portas de venezianas

3-1 Máquina de conformação de rolos para portas de venezianas

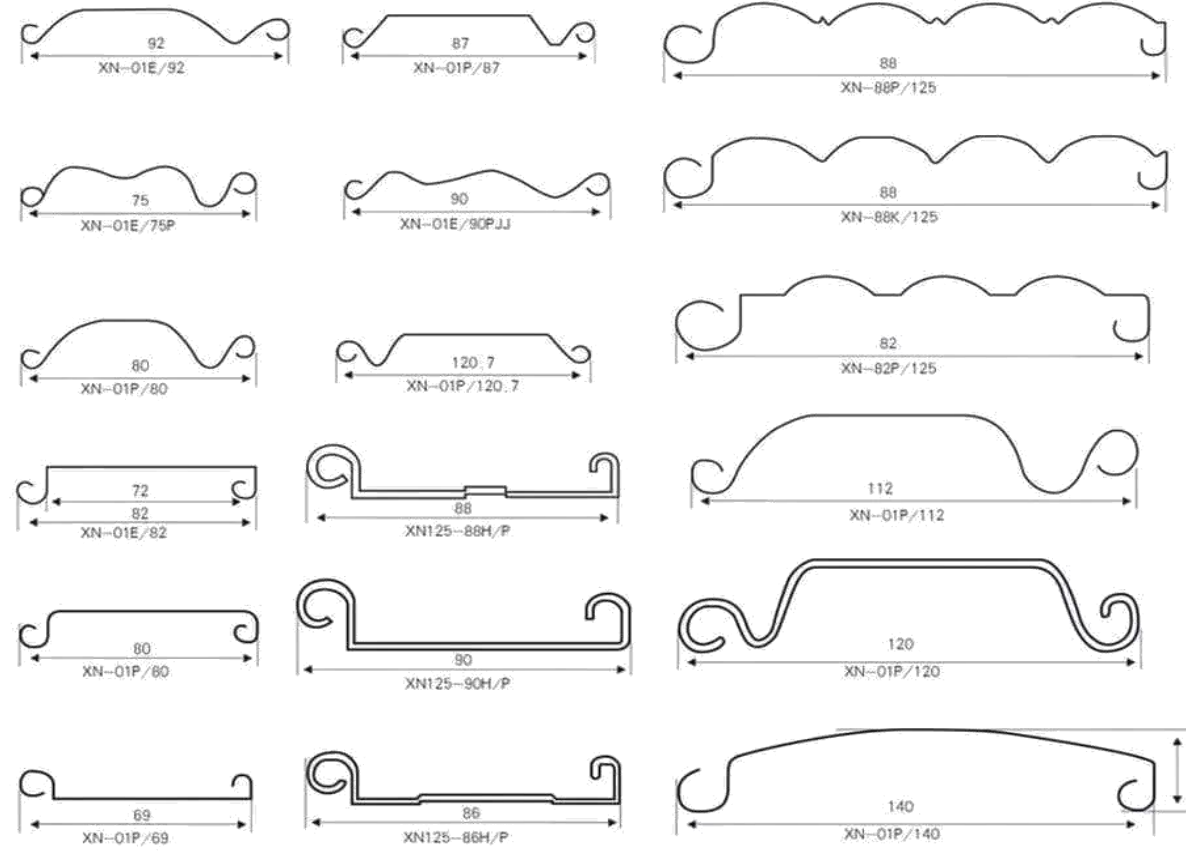
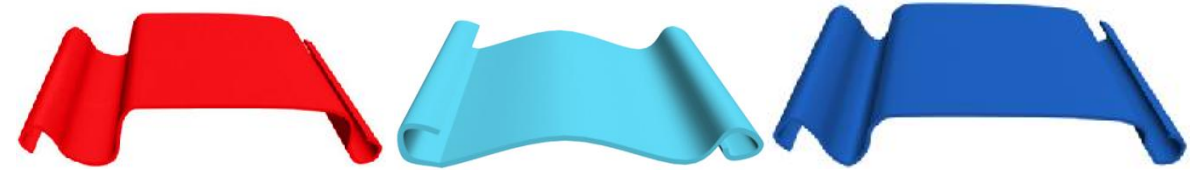
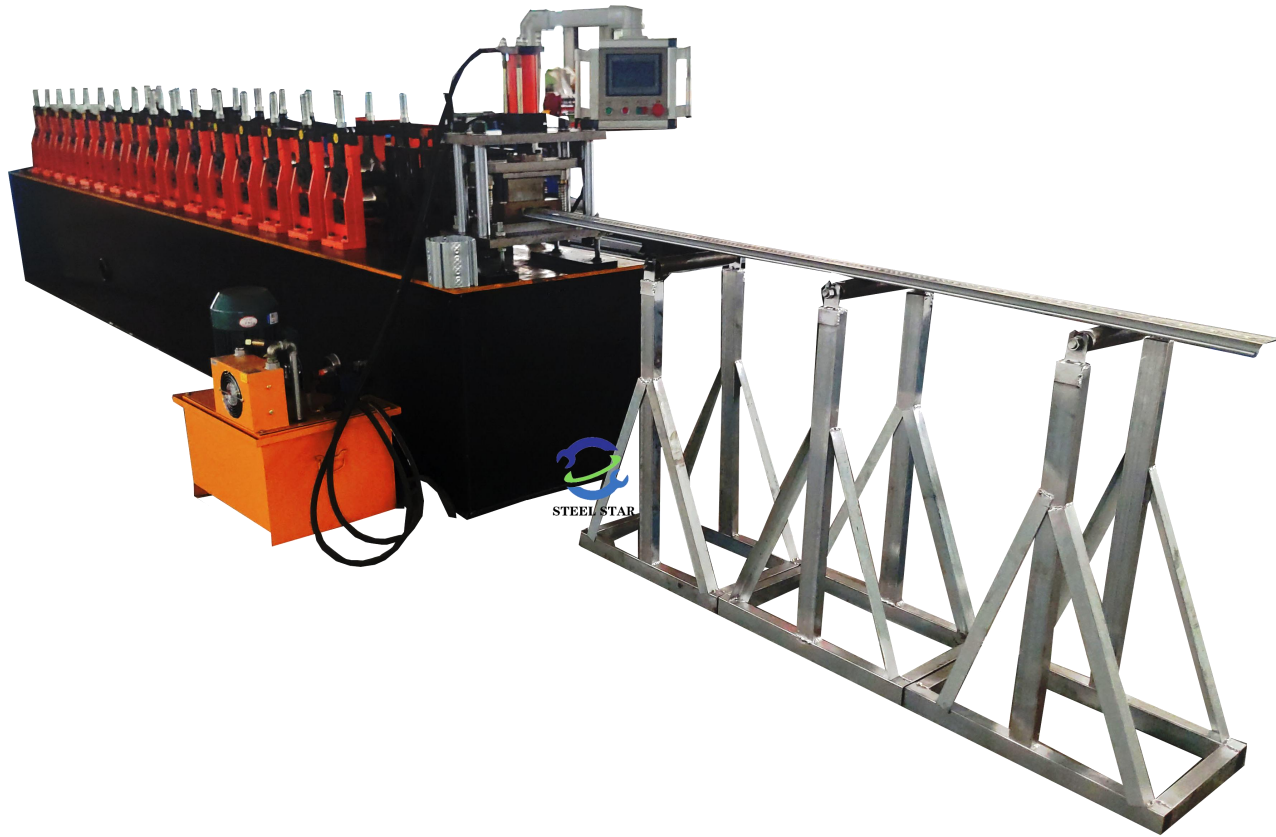



STEEL STAR
www.greatforming.com

Catálogo de produtos

3. Máquina de conformação de rolos para portas de venezianas

3-1 Máquina de conformação de rolos para portas de venezianas

Cenários de aplicação

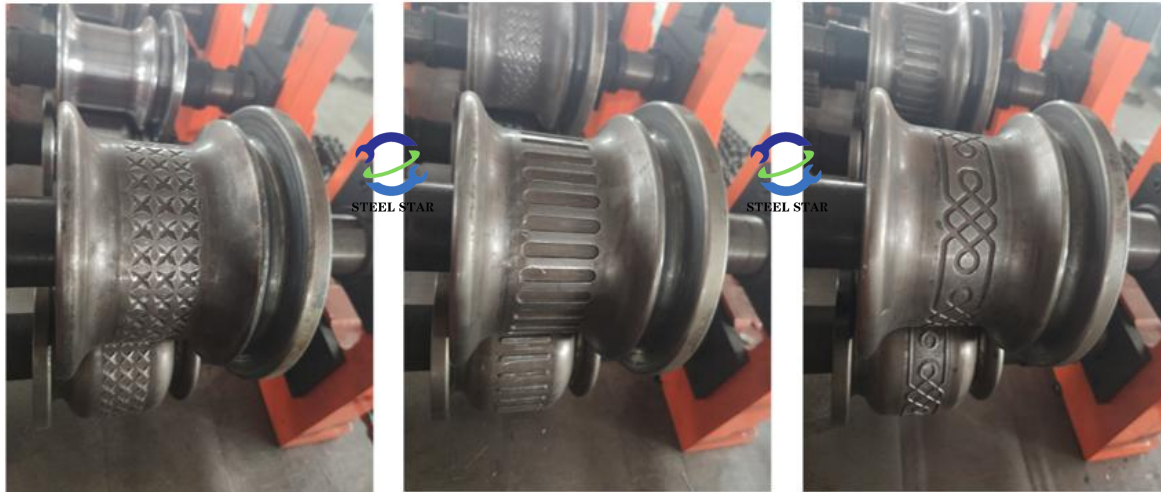



STEEL STAR
www.greatforming.com

4-1 Máquina de conformação de rolos de purlin C/Z

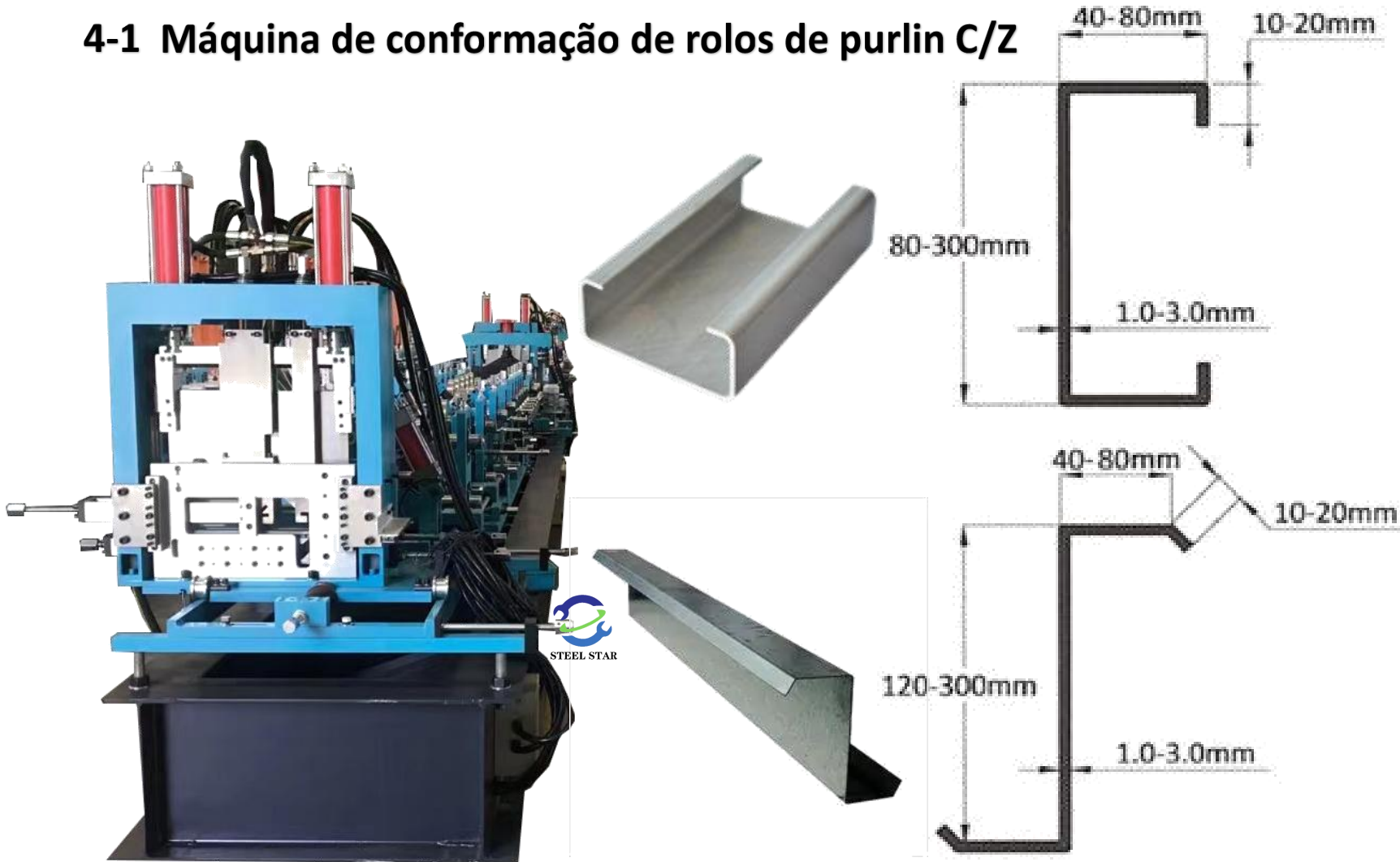

Cenários de aplicação

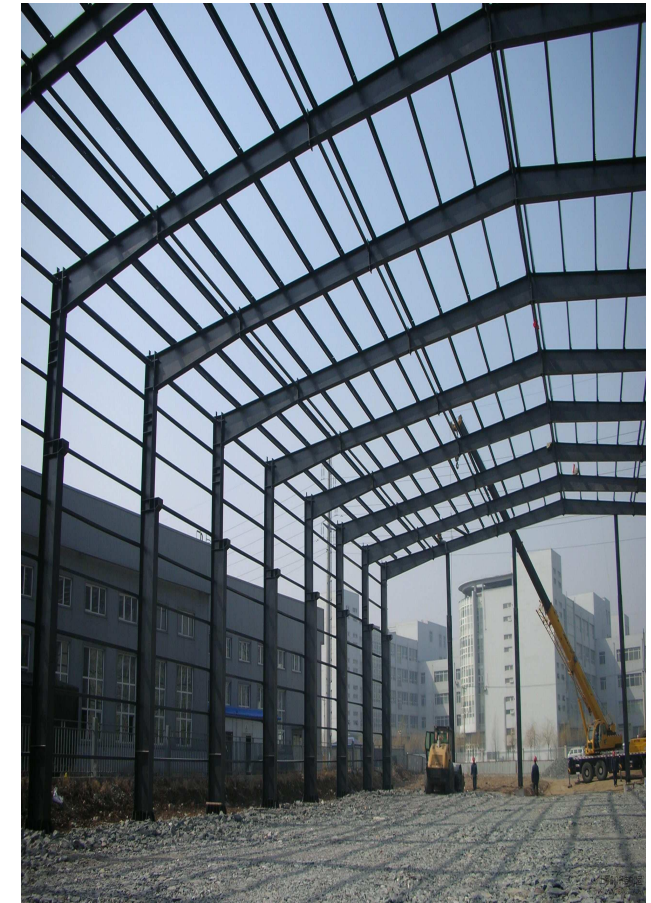



STEEL STAR
www.greatforming.com

Catálogo de produtos

5. Máquina de conformação de rolos para cumeeira

5-1 Máquina de conformação de rolos para cumeeira



Cenários de aplicação





STEEL STAR
www.greatforming.com

Catálogo de produtos

6. Máquina formadora de rolo corrugado de barril horizontal

6-1 Máquina formadora de rolo corrugado de barril horizontal

Cenários de aplicação

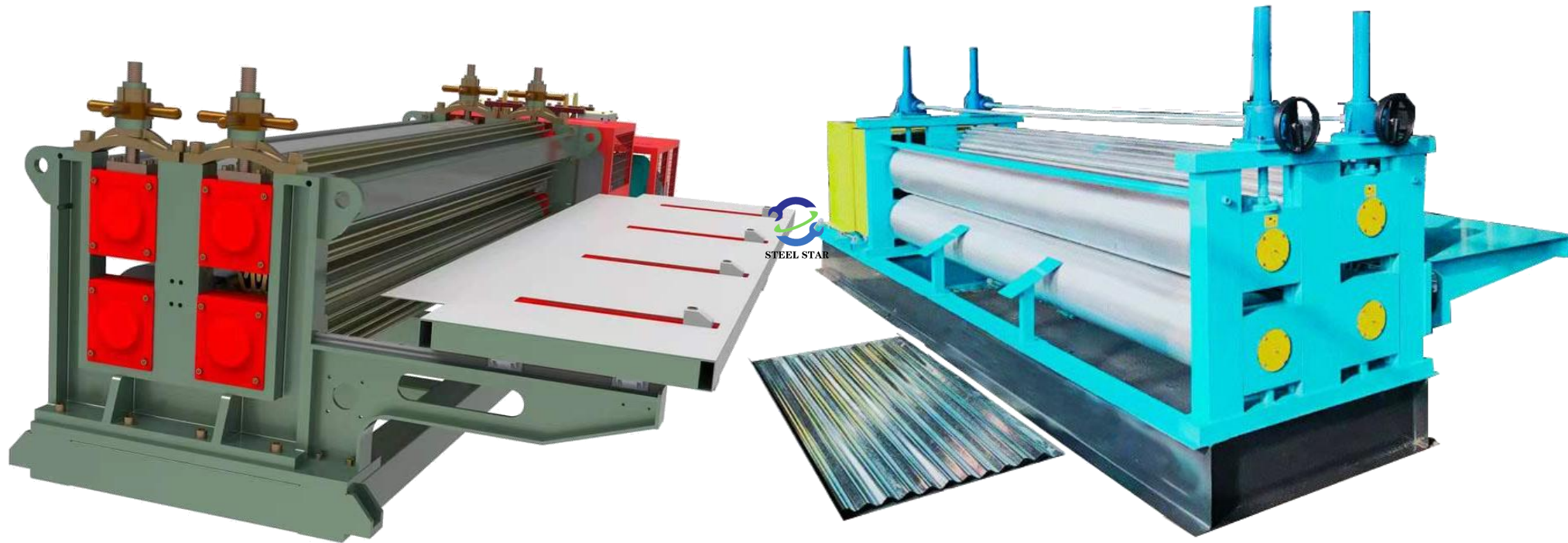



STEEL STAR
www.greatforming.com

Catálogo de produtos

7. Máquina formadora de rolo para deck de piso

7-1 Máquina formadora de rolo para deck de piso

Cenários de aplicação





STEEL STAR
www.greatforming.com

Catálogo de produtos

8. Máquina formadora de rolo para painel lateral de automóvel

8-1 Máquina formadora de rolo para painel lateral de automóvel

Cenários de aplicação

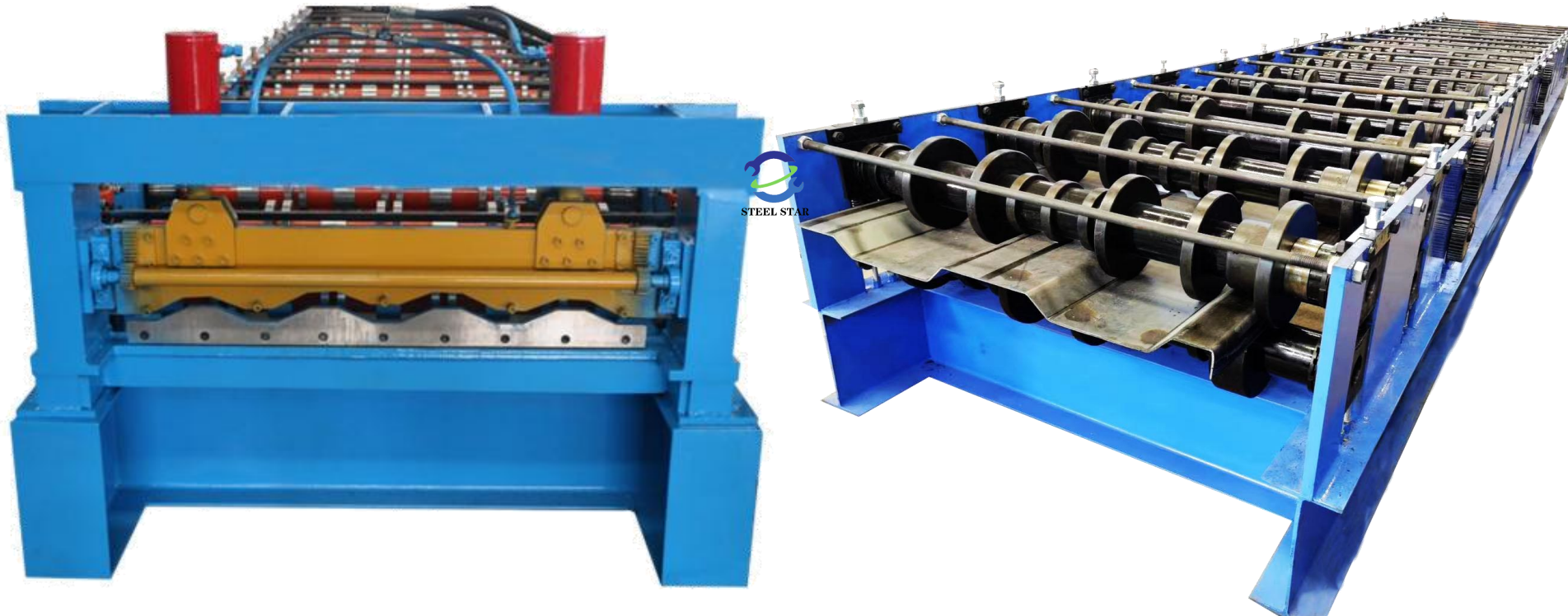



STEEL STAR
www.greatforming.com

Catálogo de produtos

9. Máquina de conformação de rolos para calhas pluviais/canos de descida

9-1 Máquina de conformação de rolos para calhas pluviais/canos de descida

Cenários de aplicação

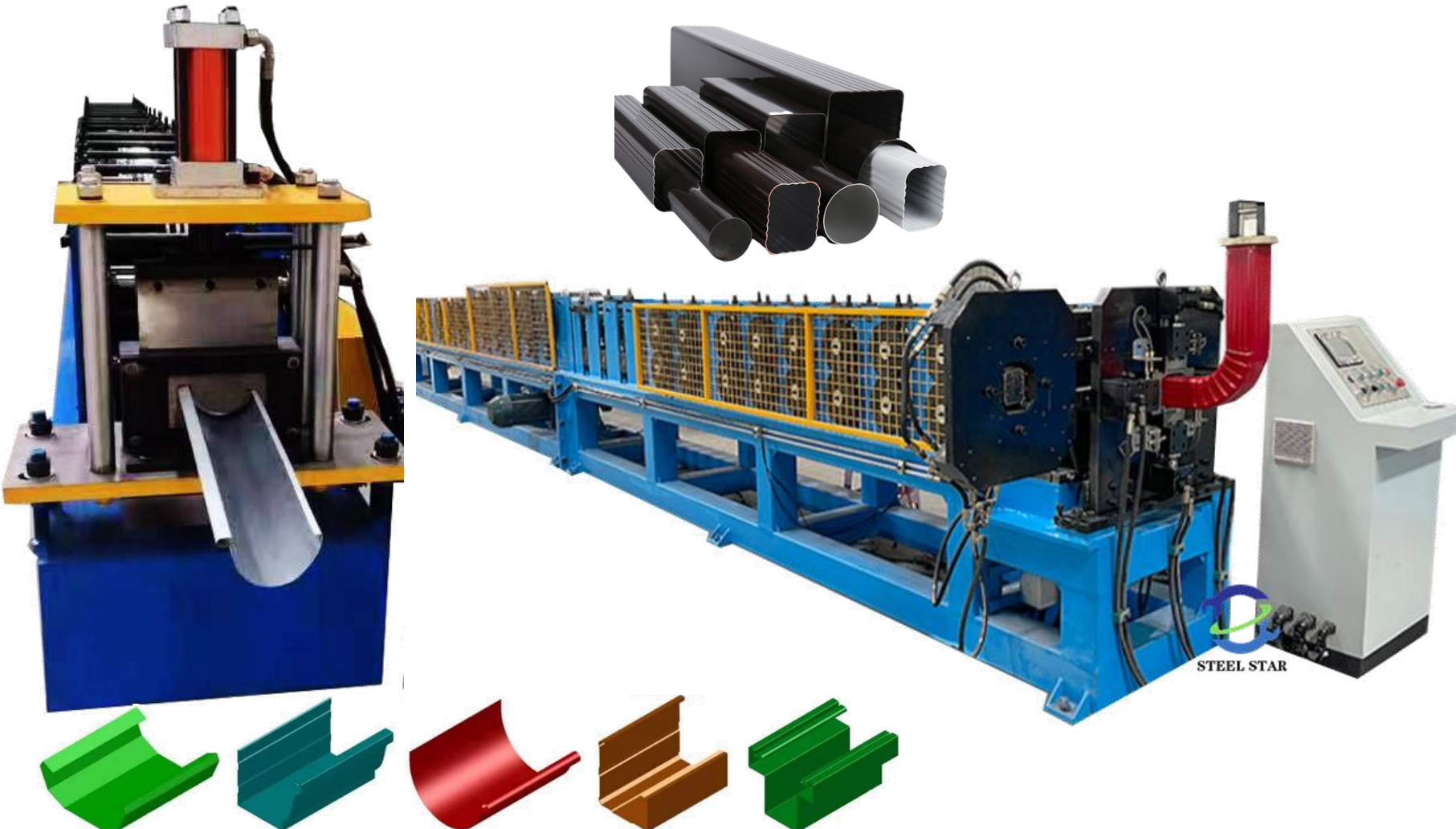



STEEL STAR
www.greatforming.com

Catálogo de produtos 10. Máquina perfiladeira de estrutura de villa de aço leve

10-1 Máquina perfiladeira de estrutura de villa de aço leve

Cenários de aplicação

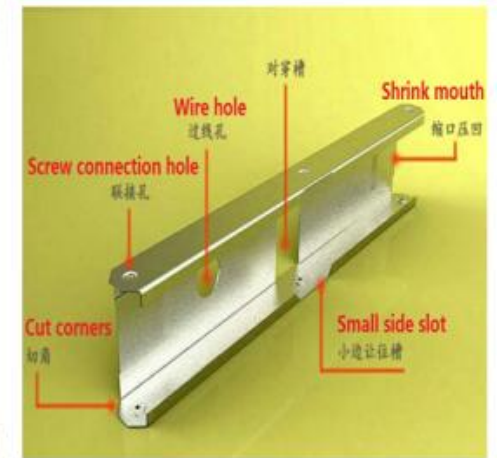
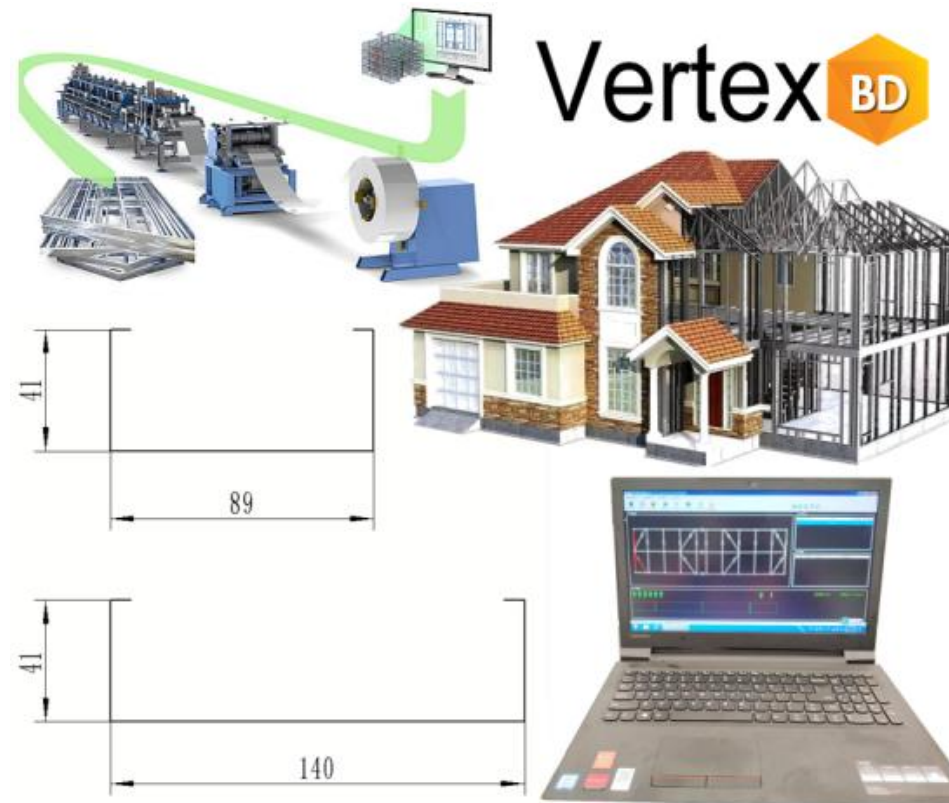

Wire hole 过线孔
Screw connection hole 联接孔
Cut corners 切角
Wire hole 对穿槽
Shrink mouth 缩口压凹
Small side slot 小边让位槽



STEEL STAR
www.greatforming.com

Catálogo de produtos

11. Máquina de conformação de rolos de chapa de guarda-corpo

11-1 Máquina de conformação de rolos de chapa de guarda-corpo

Cenários de aplicação

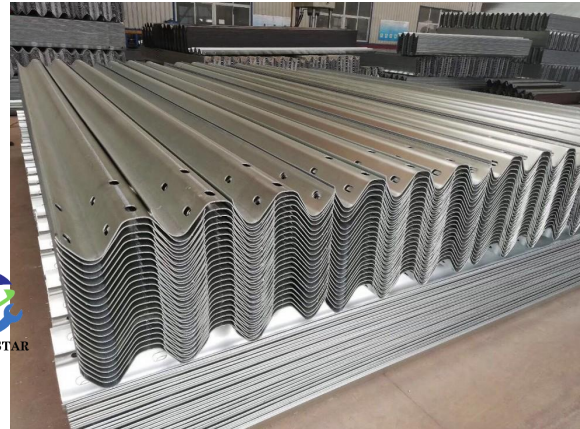



STEEL STAR
www.greatforming.com

Catálogo de produtos

12. Linha de produção de compósitos para telhados de espuma/lã de rocha para telhados de espuma/lã de rocha

12-1 Linha de produção de compósitos para telhados de espuma/lã de rocha de rocha

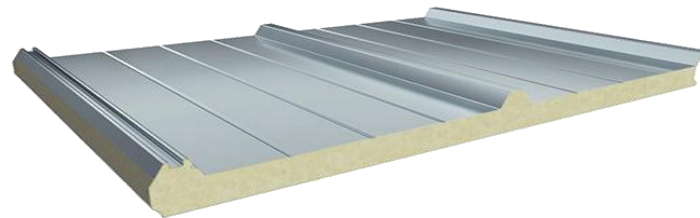
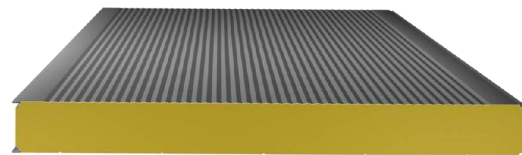
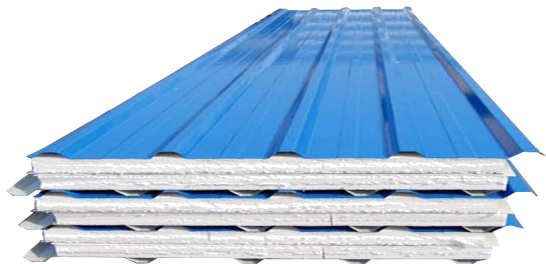

Cenários de aplicação





STEEL STAR
www.greatforming.com

Catálogo de produtos

13. Máquina de chapas para painéis de telhado Decoiler/Auto Stacker

13-1 Máquina de chapas para painéis de telhado Decoiler/Auto Stacker

Cenários de aplicação



STEEL STAR





STEEL STAR
www.greatforming.com

Catálogo de produtos 14. Máquina de dobra hidráulica/máquina de corte hidráulica

14-1 Máquina de dobra hidráulica/máquina de corte hidráulica

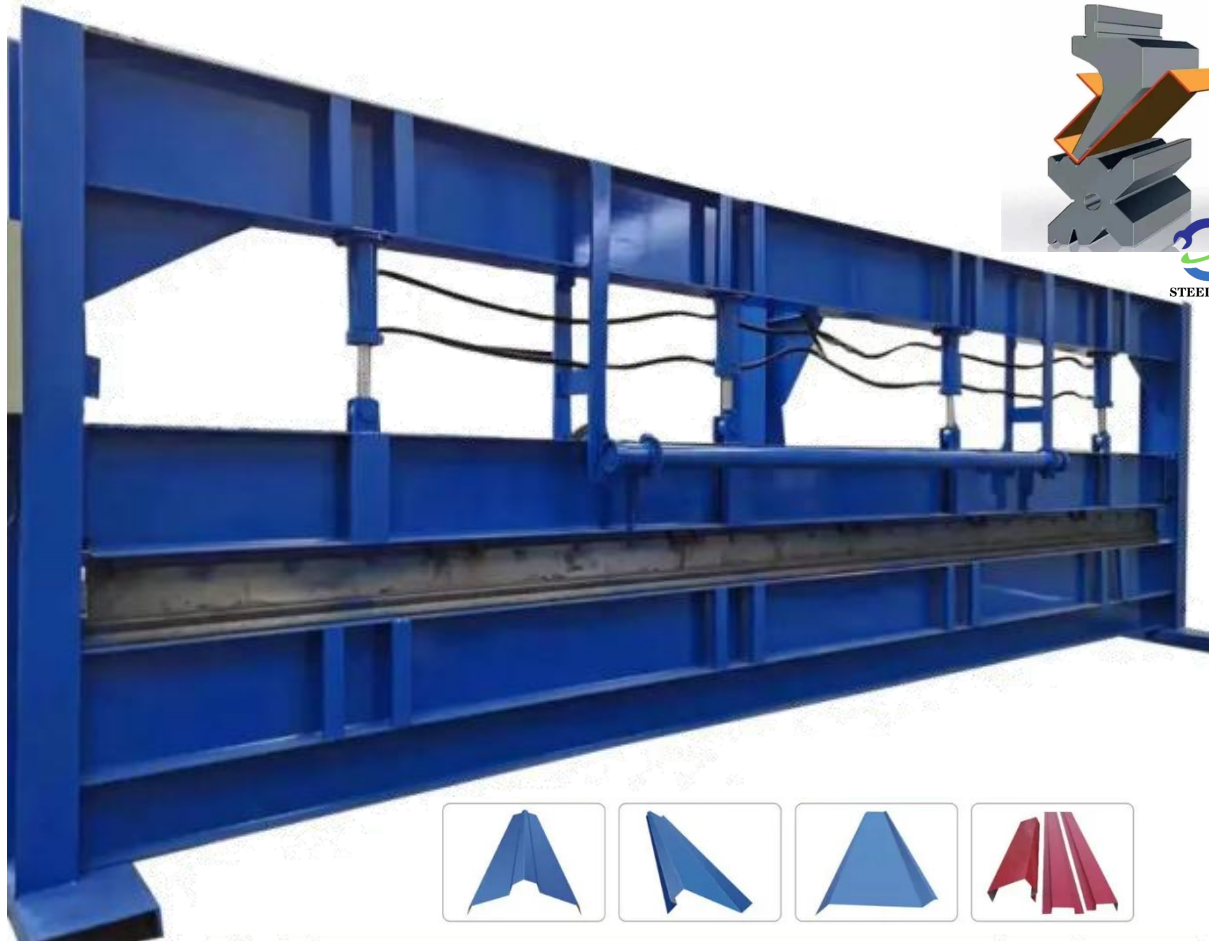



STEEL STAR
www.greatforming.com

Catálogo de produtos

15. Máquina de linha de corte de bobina de aço de aço



15-1 Máquina de linha de corte de bobina de aço

Cenários de aplicação

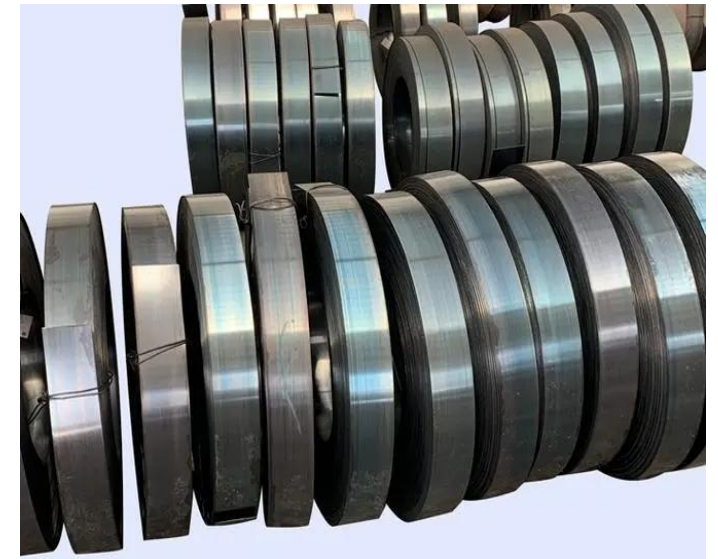
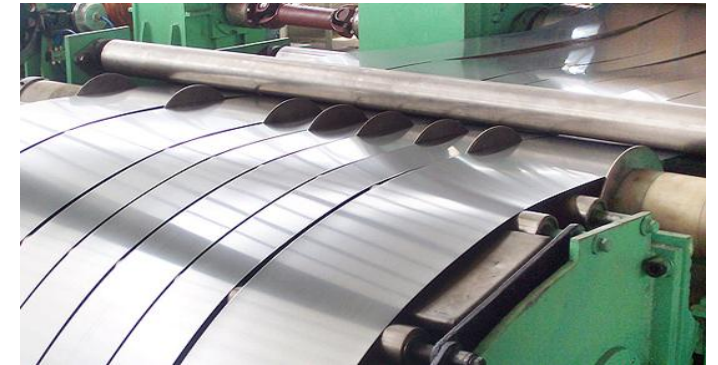



STEEL STAR
www.greatforming.com

Catálogo de produtos

16. Máquina de conformação de rolos de suporte solar

16-1 Máquina de conformação de rolos de suporte solar

Cenários de aplicação





STEEL STAR
www.greatforming.com

Catálogo de produtos 17. Máquina de fazer tubos de aço

17-1 Máquina de fazer tubos de aço



Cenários de aplicação

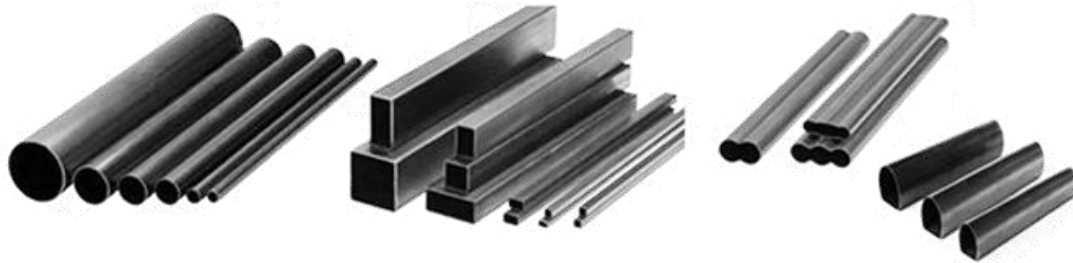

Catálogo de produtos 18. Vários produtos podem ser personalizados

18-1 Vários produtos podem ser personalizados

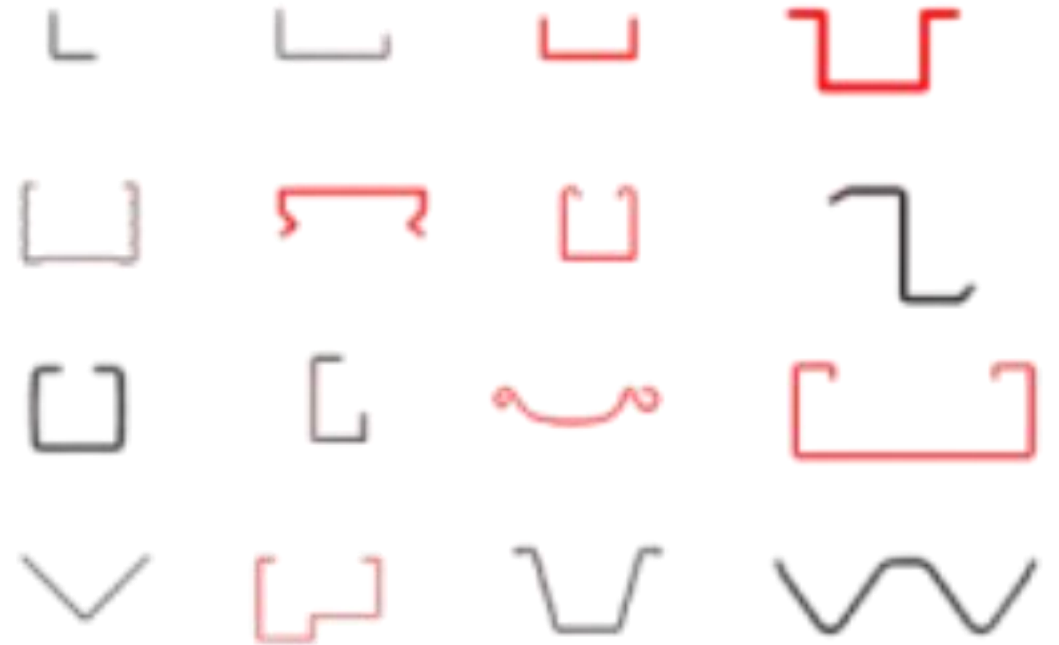



STEEL STAR
www.greatforming.com

Envio





STEEL STAR
www.greatforming.com

Serviço



Nosso serviço de atendimento ao cliente ajudará você a resolver quaisquer problemas relacionados ao sistema: nosso serviço está disponível 24 horas por dia durante os dias úteis. Responderemos às suas perguntas de forma rápida e confiável.

Se necessário, enviaremos pessoal profissional de depuração e instalação de equipamentos que poderá ir até sua cidade e ajudar você a instalar o equipamento no local.





STEEL STAR
www.greatforming.com

Contate-nos



+86 15075780050

WhatsApp Wechat(China)

Email : sam@greatforming.com

Site Oficial : www.greatforming.com



China



Beijing		1 Hour	
		4 Hour	

Tianjin		0.5 Hour	
		2.5Hour	

Jinan		1 Hour	
		3 Hour	